



MULTITOP @MATIC

Automatic security,
no more worries.



MATIC



Peace of mind lives here.

Multitop MATIC
is the new locking system
for aluminium and steel doors.

**The door is securely locked
without using the keys** 
thanks to automatic engagement
of the deadbolts.

**From inside, the door is opened
by simply** lowering the handle. 

The CISA MOTOR accessory 
also allows you to open
the door remotely.

Immediate protection
for your **home, office**
or **commercial building**.

The **Multitop MATIC** system
and its **CISA MOTOR** accessory are suitable for:

- **main entrance doors of residential buildings**
 - **main entrances doors of public
or commercial buildings**
 - **secondary entrance doors**
 - **sliding doors**



RESIDENTIAL



COMMERCIAL



ALLEGION



“Is the front door
securely locked?”
With **Multitop MATIC**
you leave your fears behind.



MULTITOP MATIC

Multitop MATIC is the new locking system for aluminium and steel doors that allows the door to be securely locked without using the keys.

Security is guaranteed with six locking points and the highest grade of the European standard.

Thanks to the **CISA MOTOR** accessory, it is also possible to remotely open the door.



MULTITOP EXIT

The **Multitop EXIT** lock will soon be available, a locking system for **aluminium and steel doors** that allows you to lock the door securely without using your keys and has an **anti-panic function**.

AVAILABLE
SOON!

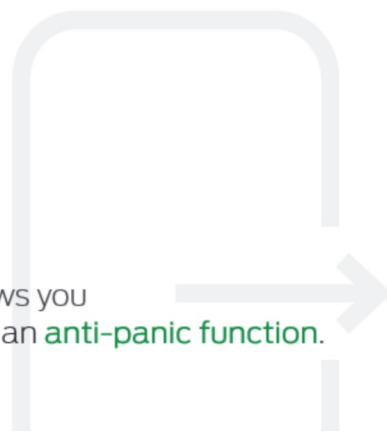



Multitop MATIC

Its strengths are your advantages.



AUTOMATIC LOCKING, ALWAYS SECURE



When the door is shut, the 3 latchbolts and the 3 hooks engage automatically.

-  the door is securely locked without using the keys
-  the door is always locked at 6 points
-  comfort and security



3 LATCHBOLTS ALWAYS ENGAGED



They guarantee hermetic closure of the door: they also guarantee the free sliding of the hooks thanks to the increased thickness latchbolts.

-  energy savings and acoustic improvement (the door is always perfectly aligned)
-  guaranteed release of hooks: once the 3 latchbolts have engaged in the strikers, the hooks are free to move without sticking (when released and withdrawn)



INTERCHANGEABILITY OF THE RECESSES ON THE PROFILE



Multitop MATIC allows you to use the recesses already present on the profiles for all locks belonging to the Multitop family (PRO and MAX), with the exception of profiles where additional work is needed in the glazing bead area. Multitop MATIC also allows you to use the same strikers of all the locks in the Multitop family.

-  same recesses used for all the locks in the Multitop family
-  the lock can be chosen even after preparing the recesses on the profile
-  reduced stock



HANDLE LOCK FUNCTION

Opening the door from the inside is immediate by simply lowering the handle. The 3 latchbolts and the 3 deadbolts are simultaneously withdrawn. This function can be excluded by turning the key in the lock closing direction.

-  the handle locks, preventing the door from being opened from the inside
-  deactivation of the CISA MOTOR if the accessory has been installed
-  greater security against attempts at forced entry from the outside



CISA MOTOR

The CISA MOTOR allows you to open the Multitop MATIC lock remotely. This accessory can be installed on request and is unique for the entire range of Multitop MATIC and EXIT locks.

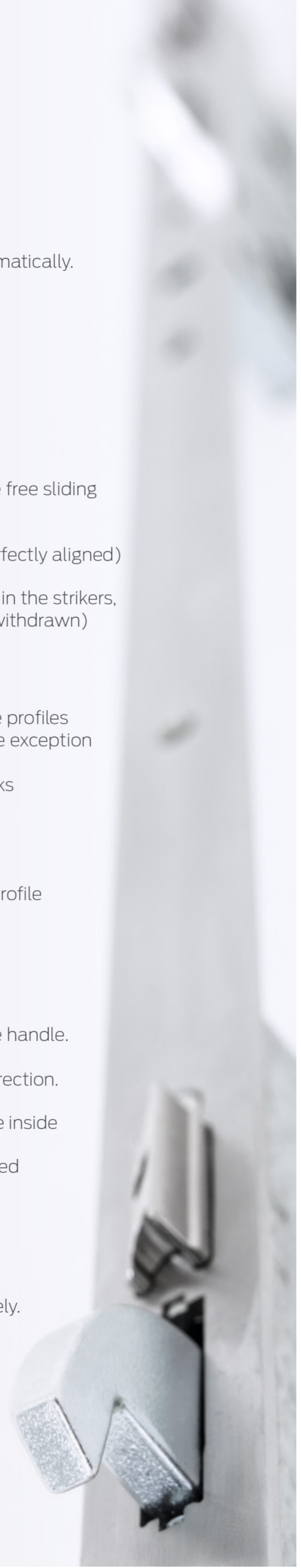

CISA MOTOR

By adding the **CISA MOTOR** accessory to the **Multitop MATIC/EXIT**, the door can be opened electrically from a distance.



REMOTE OPENING

The CISA MOTOR allows the Multitop MATIC/EXIT lock to be opened remotely even when the door is securely locked with 6 locking points.

Opening can be controlled using any credentials (intercom, keypad, transponder, card, telephone, etc.).

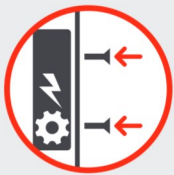

EASY-TO-MOUNT ACCESSORY

The CISA MOTOR can motorise all the locks in the Multitop MATIC/EXIT series and can be installed directly on the faceplate quickly and easily.



ELECTRIC HOLD OPEN DEVICE

Thanks to the CISA MOTOR, it is possible to activate the hold open function (door always open) at pre-defined times of the day.



SOUND/VISUAL SIGNALS

The CISA MOTOR is fitted with a sound signal and can be supplied with a visual signal (on request) to indicate opened or closed status.

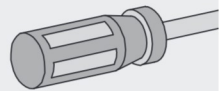

opening credentials



intercom



keypad



transponder



card



smartphone

Motor installation and electrical connections

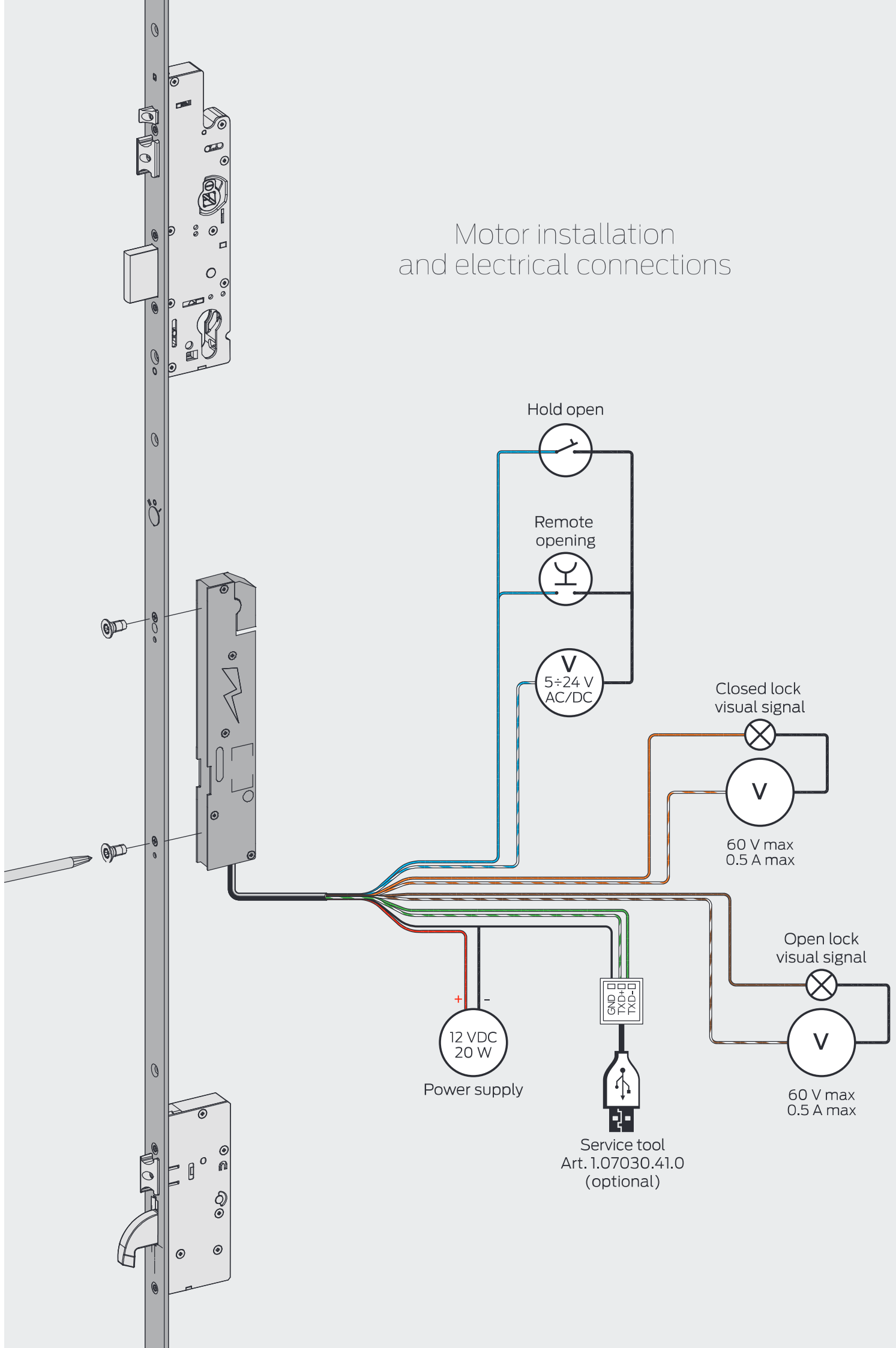

TYPE	DESCRIPTION	LOCKING POINTS	THROWS	CENTRE DISTANCE	FACEPLATE	BACKSET	UNIT WEIGHT	PCS	ITEM		
									TYPE	DIM.	HAND

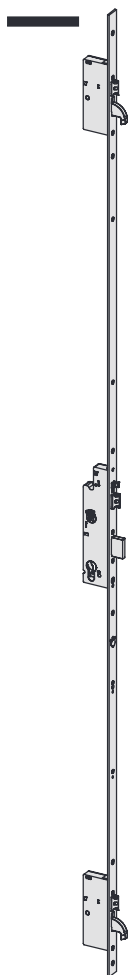

- **“Flat” adjustable faceplate 24 x 3 mm.**
In stainless steel, 2300 mm high.
- top adjustment 350 mm.
- lower adjustment 150 mm.
- 10 to 16 mm adjustable central lock deadlocking latchbolt.
- 9 to 15 mm adjustable lateral locking point 2 latchbolts.
- 9 to 15 mm adjustable “automatic reset” sensor.
- 2 hooks in hardened steel.
- SUPPLIED AS STANDARD
- pair of nylon roses item 1.06012.01.0
- lock and cylinder fixing screws
- instruction sheet
- ON REQUEST
- **CISA MOTOR item 1.E0000.00.0**
- Hold open device item 1.06120.00.0
- Top extension bolt kit for doors up to 3000 mm item 1.06444.96.0
- Cylinder protective rose item 1.06460.05.0
- Drill resistant plates for grade 7 pr EN 15685:14 item 1.06436.12/13.0

6	1	85	24	35	3,640	1	1	4A000	35	0
6	1	85	24	40	3,700	1	1	4A000	40	0
6	1	85	24	45	4,300	1	1	4A000	45	0

6	1	92	24	35	3,640	1	1	4A010	35	0
6	1	92	24	40	3,700	1	1	4A010	40	0
6	1	92	24	45	4,300	1	1	4A010	45	0

MATCHING ADJUSTABLE METAL STRIKERS

CURRENT STRIKERS		NEW STRIKERS	
Central lock item	Lateral locking points (2pcs) item	Central lock item	Lateral locking points (2pcs) item
1.06463.05.0	1.06465.05.0		
1.06463.16.0	1.06465.06.0		
1.06463.17.0 to be discontinued	1.06465.07.0 to be discontinued	replaced by 1.06463.67/68.0	replaced by 1.06465.57/58.0
1.06463.31.0 to be discontinued	1.06465.21.0 to be discontinued	replaced by 1.06463.67/68.0	replaced by 1.06465.57/58.0
1.06463.32.0 to be discontinued	1.06465.22.0 to be discontinued	replaced by 1.06463.82.0	replaced by 1.06465.72.0
1.06463.33.0 to be discontinued	1.06465.23.0 to be discontinued	replaced by 1.06463.83.0	replaced by 1.06465.73.0
1.06463.34.0 to be discontinued	1.06465.24.0 to be discontinued	replaced by 1.06463.84.0	replaced by 1.06465.74.0
1.06463.35.0 to be discontinued	1.06465.25.0 to be discontinued	replaced by 1.06463.85.0	replaced by 1.06465.75.0
1.06461.07.0	1.06461.12.0		
1.06461.17.0	1.06461.22.0		
1.06461.30.0	1.06461.34.0		
1.06461.35.0	1.06461.39.0		

TYPE	DESCRIPTION	LOCKING POINTS	THROWS	CENTRE DISTANCE	FACEPLATE	BACKSET	UNIT WEIGHT	PCS	ITEM		
									TYPE	DIM.	HAND



- **U-shaped adjustable faceplate 24 x 5 mm.**
In stainless steel, 2300 mm high.
- top adjustment 350 mm.
- bottom adjustment 150 mm.
- 10 to 16 mm adjustable central lock deadlocking latchbolt.
- 9 to 15 mm adjustable lateral locking point 2 latchbolts.
- 9 to 15 mm adjustable "automatic reset" sensor.
- 2 hooks in hardened steel.
- SUPPLIED AS STANDARD
- pair of nylon roses item 1.06012.01.0
- lock and cylinder fixing screws
- instruction sheet
- ON REQUEST
- **CISA MOTOR item 1.E0000.00.0**
- Hold open device item 1.06120.00.0
- Top extension bolt kit for doors up to 3000 mm item 1.06444.86.0
- Cylinder protective rose item 1.06460.05.0
- Protective plates item 1.06436.12/13.0

6	1	85	24	35	3,640	1	1	4A100	35	0
6	1	85	24	40	3,700	1	1	4A100	40	0
6	1	85	24	45	4,300	1	1	4A100	45	0
6	1	92	24	35	3,640	1	1	4A110	35	0
6	1	92	24	40	3,700	1	1	4A110	40	0
6	1	92	24	45	4,300	1	1	4A110	45	0

- **U-shaped adjustable faceplate 24 x 7 mm.**
In stainless steel, 2300 mm high.
- top adjustment 350 mm.
- bottom adjustment 150 mm.
- 10 to 16 mm adjustable central lock deadlocking latchbolt.
- 9 to 15 mm adjustable lateral locking point 2 latchbolts.
- 9 to 15 mm adjustable "automatic reset" sensor.
- 2 hooks in hardened steel.
- SUPPLIED AS STANDARD
- pair of nylon roses item 1.06012.01.0
- lock and cylinder fixing screws
- instruction sheet
- ON REQUEST
- **CISA MOTOR item 1.E0000.00.0**
- Hold open device item 1.06120.00.0
- Top extension bolt kit for doors up to 3000 mm item 1.06444.87.0
- Cylinder protective rose item 1.06460.05.0
- Drill resistant plates for grade 7 pr EN 15685:14 item 1.06436.12/13.0

6	1	85	24	35	3,640	1	1	4A200	35	0
6	1	85	24	40	3,700	1	1	4A200	40	0
6	1	85	24	45	4,300	1	1	4A200	45	0
6	1	92	24	35	3,640	1	1	4A210	35	0
6	1	92	24	40	3,700	1	1	4A210	40	0
6	1	92	24	45	4,300	1	1	4A210	45	0

MATCHING ADJUSTABLE METAL STRIKERS

CURRENT STRIKERS		NEW STRIKERS	
Central lock item	Lateral locking points (2pcs) item	Central lock item	Lateral locking points (2pcs) item
1.06463.05.0	1.06465.05.0		
1.06463.16.0	1.06465.06.0		
1.06463.17.0 to be discontinued	1.06465.07.0 to be discontinued	replaced by 1.06463.67/68.0	replaced by 1.06465.57/58.0
1.06463.31.0 to be discontinued	1.06465.21.0 to be discontinued	replaced by 1.06463.67/68.0	replaced by 1.06465.57/58.0
1.06463.32.0 to be discontinued	1.06465.22.0 to be discontinued	replaced by 1.06463.82.0	replaced by 1.06465.72.0
1.06463.33.0 to be discontinued	1.06465.23.0 to be discontinued	replaced by 1.06463.83.0	replaced by 1.06465.73.0
1.06463.34.0 to be discontinued	1.06465.24.0 to be discontinued	replaced by 1.06463.84.0	replaced by 1.06465.74.0
1.06463.35.0 to be discontinued	1.06465.25.0 to be discontinued	replaced by 1.06463.85.0	replaced by 1.06465.75.0
1.06461.07.0	1.06461.12.0		
1.06461.17.0	1.06461.22.0		
1.06461.30.0	1.06461.34.0		
1.06461.35.0	1.06461.39.0		

TYPE	DESCRIPTION	FOR SERIES/ ITEM	FACEPLATE	UNIT WEIGHT	PCS	ITEM			
						TYPE	DIM.	HAND	
	<ul style="list-style-type: none"> CISA MOTOR for installation on all multipoint Multitop MATIC locks. It allows remote electric opening <ul style="list-style-type: none"> - CE 12V DC voltage - Absorbed current 2A SUPPLIED AS STANDARD <ul style="list-style-type: none"> - power supply cable art. 1.07030.40.0 (L=4 m) - 2 fixing screws - instruction sheet 	4A010, 4A100, 4A110, 4A200, 4A210	-	0,500	1	1	E0000	00	0
	<ul style="list-style-type: none"> Concealed cable guard with spring. 			0,058	6	1	06515	00	0
	<ul style="list-style-type: none"> Inside escutcheon with spring. 			0,325	6	1	06515	15	0
	<ul style="list-style-type: none"> External cable guard with spring (L=300 mm). 			0,100	10	1	06515	20	0
	<ul style="list-style-type: none"> External cable guard with spring (L=600 mm). 			0,100	10	1	06515	21	0
	<ul style="list-style-type: none"> Red LED. 			0,005	1	1	07126	01	0
	<ul style="list-style-type: none"> Green LED. 			0,019	1	1	07126	02	0
	<ul style="list-style-type: none"> Cabled keypad for individual access control by PIN code, for E0000 series CISA MOTOR. Polished black finish. AVAILABLE FINISHES <ul style="list-style-type: none"> - Satin finished chrome (fin. B1) 	E0000	-	0,500	1	1	06525	77	0
	<ul style="list-style-type: none"> Power supply cable (L=4 m) 			0,019	1	1	07030	40	0
	<ul style="list-style-type: none"> Service cable. 			0,019	1	1	07030	41	0
	<ul style="list-style-type: none"> Power supply: <ul style="list-style-type: none"> - Input: 100÷240 Vac - 50/60 Hz - 0.7 A - Output: 12 Vdc - 2.5 A - Output Class 2 - UL Listed Certificated 		-	0,250	1	1	07060	10	0

TYPE	DESCRIPTION	LOCKING POINTS	THROWS	CENTRE DISTANCE	FACEPLATE	BACKSET	UNIT WEIGHT kg	PCS	ITEM		
									TYPE	DIM.	HAND

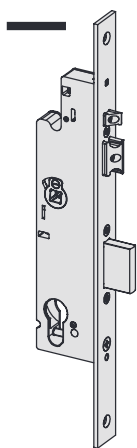





- **Stainless steel faceplate 24 x 3 mm.**
- Deadbolt and latch bolt
- 10 to 16 mm adjustable deadlocking latchbolt.
- 9 to 15 mm adjustable "automatic reset" sensor.
- SUPPLIED AS STANDARD
 - pair of nylon roses item 1.06012.01.0
 - lock and cylinder fixing screws
 - instruction sheet
- ON REQUEST
 - Cylinder protective rose item 1.06460.05.0

1	2	85	24	35	1,130	1	1	4A300	35	0
1	2	85	24	40	1,190	1	1	4A300	40	0
1	2	85	24	45	1,790	1	1	4A300	45	0
3	2	92	24	35	3,640	1	1	4A310	35	0
3	2	92	24	40	3,700	1	1	4A310	40	0
3	2	92	24	45	4,300	1	1	4A310	45	0

MATCHING ADJUSTABLE METAL STRIKERS



CURRENT STRIKERS	NEW STRIKERS
1.06463.05.0	
1.06463.16.0	
1.06463.17.0 to be discontinued	replaced by 1.06463.67/68.0
1.06463.31.0 to be discontinued	replaced by 1.06463.67/68.0
1.06463.32.0 to be discontinued	replaced by 1.06463.82.0
1.06463.33.0 to be discontinued	replaced by 1.06463.83.0
1.06463.34.0 to be discontinued	replaced by 1.06463.84.0
1.06463.35.0 to be discontinued	replaced by 1.06463.85.0
1.06461.07.0	
1.06461.17.0	
1.06461.30.0	
1.06461.35.0	

TYPE	DESCRIPTION	FOR SERIES/ ITEM	FACEPLATE	kg		ITEM			
				UNIT WEIGHT	PCS	TYPE	DIM.	HAND	
	<ul style="list-style-type: none"> Hold open device for 4A000 series Multitop MATIC locks, 2 different modes: <ul style="list-style-type: none"> - hold open (withdrawn latchbolts and deadbolts); - semi-automatic function (only with withdrawn deadbolts). 	4A010, 4A100, 4A110, 4A200, 4A210	-	0,020	6	1	06120	00	0
	<ul style="list-style-type: none"> Top extension bolt kit for doors up to 3000 mm. U-shaped adjustable faceplate 24 x 5 mm in STAINLESS steel, 700 mm high. 	4A100, 4A110	24	0,900	1	1	06444	86	0
	<ul style="list-style-type: none"> Top extension bolt kit for doors up to 3000 mm. U-shaped adjustable faceplate 24 x 7 mm in STAINLESS steel, 700 mm high. 	4A200, 4A210	24	0,900	1	1	06444	87	0
	<ul style="list-style-type: none"> Top extension bolt kit for doors up to 3000 mm. "Flat" adjustable faceplate 24 x 3 mm in STAINLESS steel, 700 mm high. 	4A000, 4A010	24	0,900	1	1	06444	96	0
	<ul style="list-style-type: none"> Lock protective plate, to increase drill resistance (grade 7 prEN 15685: 14). 	4A000, 4A010, 4A100, 4A110, 4A200, 4A210		0,100	6	1	06436	12	0
	<ul style="list-style-type: none"> Protective plate for lateral locking points, to increase drill resistance (grade 7 prEN 15685: 14). 	4A000, 4A010, 4A100, 4A110, 4A200, 4A210		0,057	12	1	06436	13	0

MULTITOP MATIC



SECURITY AND CERTIFICATIONS

The lock is certified to the highest grades of the European Standards prEN15685:14 (mechanical) and EN14846:08 (mechanical + CISA MOTOR) and is suitable for doors certified to EN1627:11 up to resistance class WK/RC 4.

-  Resistance to burglary is 1,000 kg lateral force and 600 kg attempt to break the profile.
-  The 2 hardened steel hooks are independent of each other and of the central lock mechanism: if one of the deadbolts or hooks is forced, the other locking points remain securely engaged.

OTHER FUNCTIONS

With only one accessory installed (item 1.06120.00.0), the Multitop MATIC lock can have two additional locking functions:

-  **Door locked with only the latchbolts engaged** function (semi-automatic) can be activated directly on the lock faceplate: the deadbolts are deactivated and the door remains locked with only the 3 latchbolts engaged.
-  **Doors always open** function (hold open) can be activated directly on the lock faceplate: the deadbolts and the latchbolts never engage.

MULTITOP EXIT



The **Multitop EXIT** lock will soon be available.

The door is always securely locked at 6 locking points without having to use your keys: two independent hooks on the lateral locking points and one central deadbolt, in addition to the three latchbolts. The door can always be opened from the inside using the handle or panic exit device, despite the secure locking system. Suitable for both single and double doors. In the latter case, a secondary lock must be used.

The features and benefits will be the same as those of the Multitop MATIC with the exception of the handle lock function as the handle or the panic exit device must always be active as required by current regulations.

When the CISA MOTOR accessory is used, it will always be possible to open the door remotely with an electrical impulse through a button.

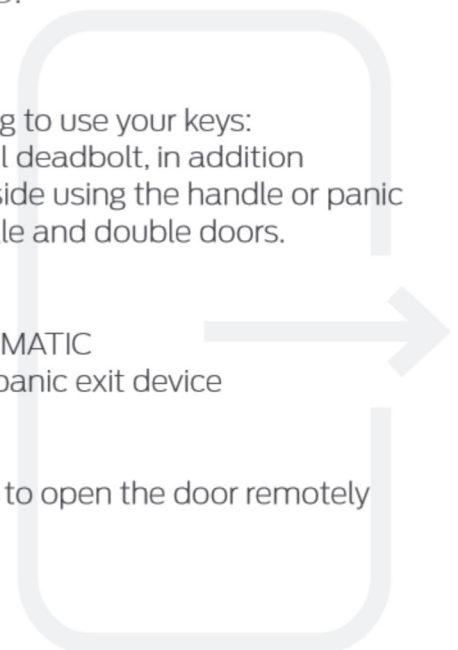

Technical features

- Case thickness 15.5 mm
- Closed case
- Backsets 35/-40/-45 mm
- Centre distance 85 and 92 mm
- Case in zinc-plated pressure die-cast metal
- Zinc-plated steel cover
- Stainless steel top and bottom adjustable faceplate
- 10 to 16 mm adjustable central lock deadlocking latchbolt
- 9 to 15 mm adjustable lateral locking point 2 latchbolts
- 9 to 15 mm adjustable “automatic reset” sensor
- Central deadbolt with 20 mm protrusion
- 8 mm thick lateral locking point hooks with 25 mm protrusion in hardened steel
- 16 mm hooks
- Protective plate for grade 7 item 1.06436.12/13.0
- Pre-set for installation of microswitch on the lateral locking point cases
- 8 mm square spindle
- DIN holes to fix the handle plate
- Non-handed

Supplied as standard

- Pair of nylon roses item 1.06012.01.0
- Lock and cylinder fixing screws
- Instructions sheet

CISA MOTOR

Technical features

- Case thickness 15.5 mm
- CE 12V DC voltage
- Absorbed current 2A
- Sound signal to indicate open or closed status (deadbolt status)
- Sound signal to indicate any installation error (see user manual for further details)
- Optional light signal (see special accessories)

On request

- CISA MOTOR accessory for motorised opening (item 1.E0000.00.0)
- Hold open device / semi-automatic function (item 1.06120.00.0)
- Euro profile cylinder
- Adjustable metal strikers (see special vademecum)
- Cylinder protective rose item 1.06460.05.0
- Top extension bolt kit 1.06444.86/87/96.0

Certifications

- Grade 6 Security to prEN15685:14 (mechanical) and EN14846:08 (mechanical + CISA MOTOR)
- Grade 7 Security to prEN15685:14 (mechanical) and EN14846:08 (mechanical + CISA MOTOR) using protective plates for the lock and the lateral locking points item 06436
- Suitable for doors certified to EN1627:11 up to resistance class WK/RC4
- MULTITOP MATIC with the CISA MOTOR accessory complies with:
 - Directive 2014/30/EU (EMC, electromagnetic compatibility)
 - REACH No 1907/2006
 - RoHS (Directive 2011/65/EU)
 - RoHS 2 (Directive 2015/863)

- Possibility to customise the time during which the motor remains active during the opening, connecting to the PC with a USB cable (factory set at 3 seconds)
- If the “handle lock” function is activated, the motor is automatically switched off
- In the event of a power failure, it is still possible to open the door with the keys

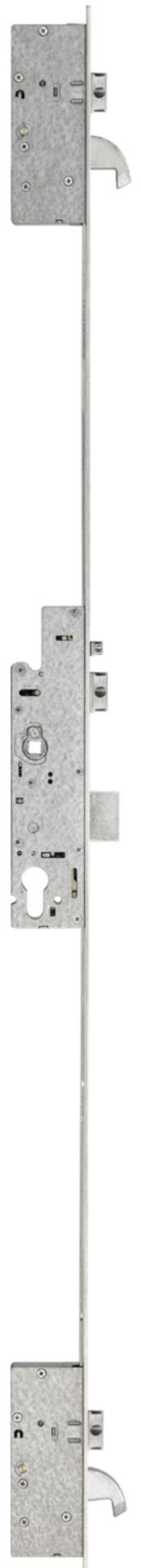

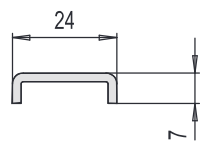
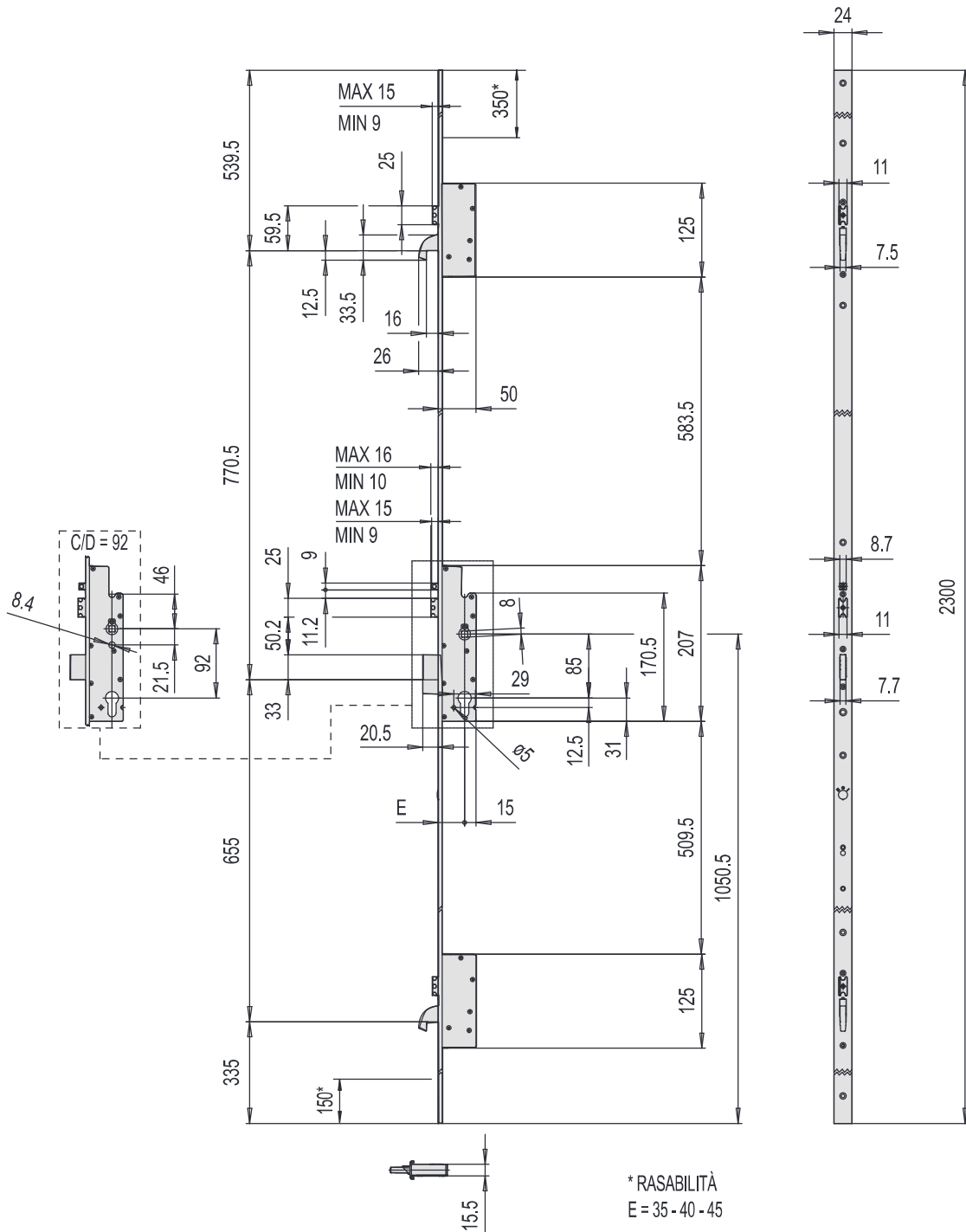

4A200 l = 85
4A210 l = 92

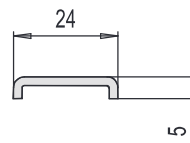

4A100 l = 85
4A110 l = 92

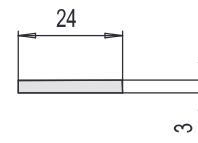

4A000 l = 85
4A010 l = 92

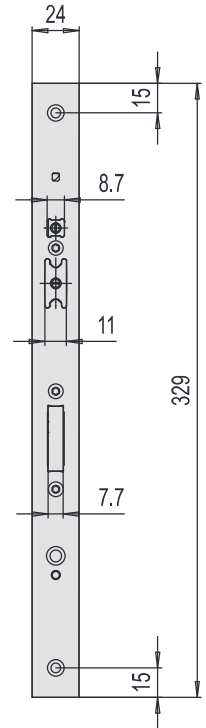
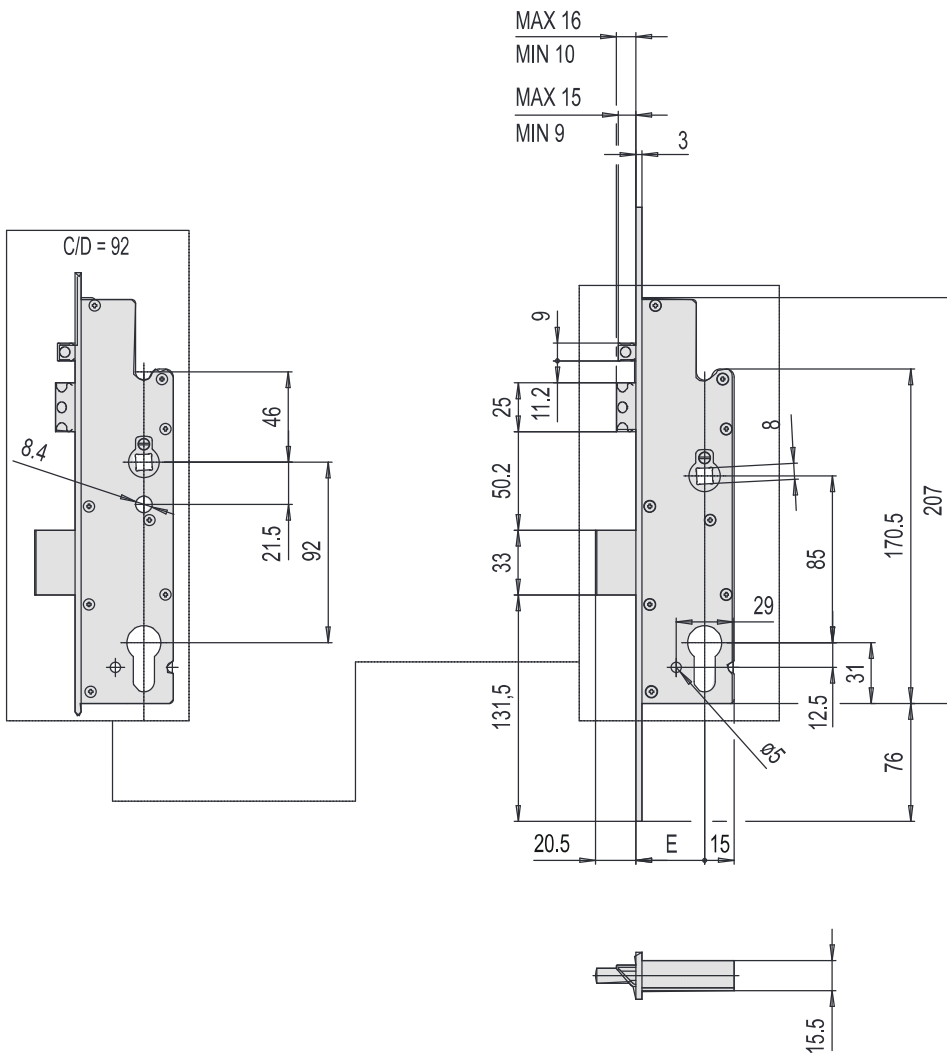

4A300
4A310

I = 85
I = 92

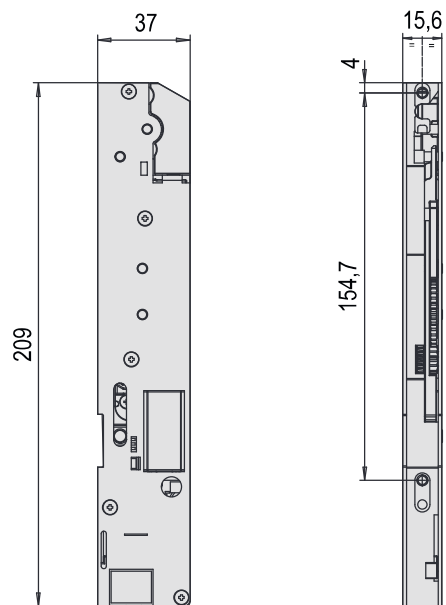

E0000



CISA



Learn more

CISA

MULTITOP
MATIC

SECURE, COMFORTABLE,
PRACTICAL.

CISA
MOTOR

SECURE FLEXIBILITY
AND EVOLUTION.

By using Multitop MATIC with the CISA MOTOR,
the lock can be motorised.

The door can be opened **remotely**
even when it is securely locked in six points.

remote opening



opening credentials



intercom



keypad



transponder



card



smartphone

About Allegion™

Allegion (NYSE: ALLE) is a global pioneer in seamless access, with leading brands like CISA®, Interflex®, LCN®, Schlage®, SimonsVoss® and Von Duprin®. Focusing on security around the door and adjacent areas, Allegion secures people and assets with a range of solutions for homes, businesses, schools and institutions. Allegion had \$2.7 billion in revenue in 2018, and sells products in almost 130 countries.

For more, visit allegion.com.



 CISA SpA
Via Oberdan 42
48018 Faenza (RA) Italy

 Ph. +39 0546 677111
Fax +39 0546 677150

 Customer Service and Technical Support
+39 0546 188 0070

   cisa.com
cisa.sales@allegion.com